

Solar LED Street Light - FB Series

40W/50W/60W/80W/100W/120W



IP66

IK09

FB Series integrated solar street lamp use imported high-efficiency monocrystalline silicon solar panel , smart MPPT controller, deep cycle lithium battery, high-efficiency led chip, all in one box Integrated design, easy to install and use and maintenance for seperated battery box



Application

1. Street Lighting, Road Lighting, Roadway Lighting
2. Outdoor Area Lighting, High Mast Lighting
3. Park, schools, square, Parking lots



Features

1. Designed by a professional industrial design team, integrating solar panels, led sources, controller, battery, human body induction, and housing.
2. Adjustable angle mounting bracket, suitable for a variety of modeling lamp pole installation methods.
3. Intelligent power adjustment, automatic weather judgment, reasonable planning of discharge rules
4. Intelligent charging and discharging management, soft and hard double protection of charging and discharging and intelligent equalization technology, battery cycles more than 2000 times.
5. Smart remote control, equipped with drone remote control, ultra-long remote control distance of 30 meters, can pass through obstacles, and can set four lighting modes at will.
6. High-efficiency Bridgelux brand LED chips can reach 220LM/W, which is more than twice the average brightness of ordinary LED light sources, with luminous angle of 140 degrees, and a wider irradiation area.
7. The whole lamp adopts modular minimalist design, easy disassembly, installation, and transportation.

Installation Height



Dimension(mm)

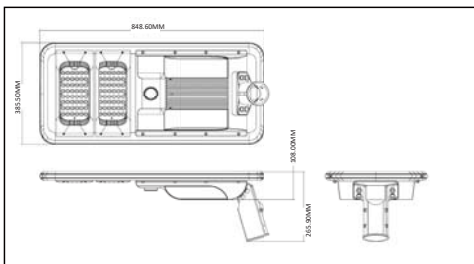

FB-40W

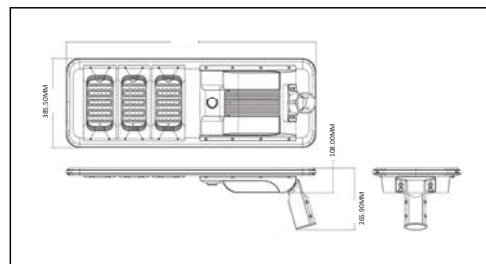

FB-50W

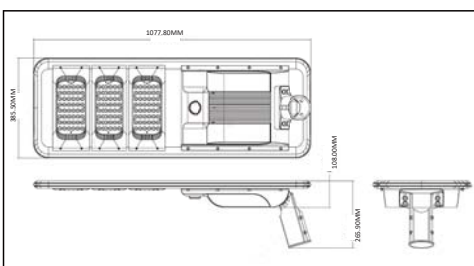

FB-60W

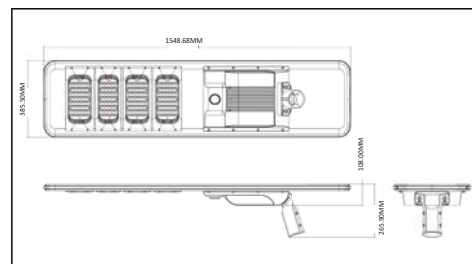

FB-80W

Dimension(mm)

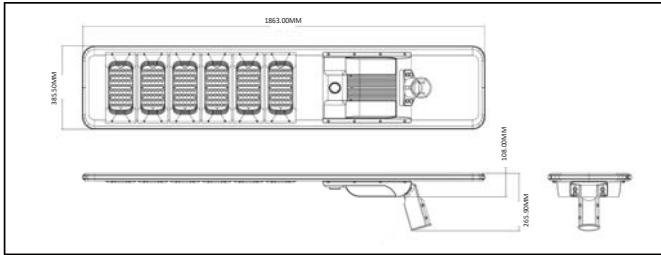

FB-100W

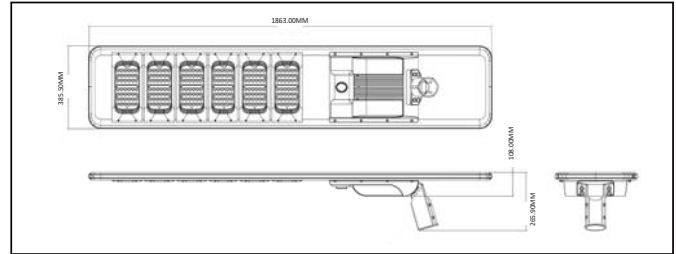

FB-120W

Technical Specification

A: Technical Parameter

| Model | HE-FB-40W | HE-FB-50W | HE-FB-60W | HE-FB-80W | HE-FB-100W | HE-FB-120W |
|-----------------------|-----------------------------------------------------------------------------------------------------------------------------|----------------|----------------|----------------|----------------|----------------|
| Lumens(Energy-Saving) | 4200lm | 5310LM | 6400LM | 8545LM | 10685LM | 12818LM |
| Solar Panel | 65W | 70W | 80W | 100W | 130W | 140W |
| Mount Height | 5-7m | 6-7m | 6-8m | 7-9m | 9-12m | 9-12m |
| Mount Space | 17-23m | 20-23m | 20-27m | 23-30m | 30-40m | 30-40m |
| LiFeO4(WH) | 345.6WH | 460.8WH | 537.6WH | 729.6WH | 806.4WH | 921.6WH |
| Dimension(Lamp) | 849*386*108mm | 1078*386*108mm | 1078*386*108mm | 1549*386*108mm | 1863*386*108mm | 1863*386*108mm |
| LED Source(Bridgelux) | 96 | 144 | 144 | 192 | 288 | 288 |
| Cloudy/Rainy days | 3-5Cloudy/Rainy days | | | | | |
| Solar Charging Time | 6 hours by bright sunlight | | | | | |
| Motion sensor | Yes | | | | | |
| Beam Angle | Typell -M | | | | | |
| IP Rating | IP66 | | | | | |
| CCT | 2700~6500K(Customized) | | | | | |
| Install Pole diameter | HE-FB-40W/50W/60W (60-65mm) / HE-FB-80W/100W/120W (70-76mm) | | | | | |
| Lighting Mode | Dusk to dawn + Time control + motion sensor (Bright lighting 30secs when people move through the light) + Remote Controller | | | | | |
| Material | High Class Aluminum | | | | | |

B: Environmental

| | |
|-----------------------------|-------------|
| Temperature Range Operating | -20℃ to 50℃ |
| Humidity Range Operating | 10% to 80% |
| Temperature Range Storage | -40℃ to 65℃ |
| Humidity Range Storage | 10% to 80% |

Components Features

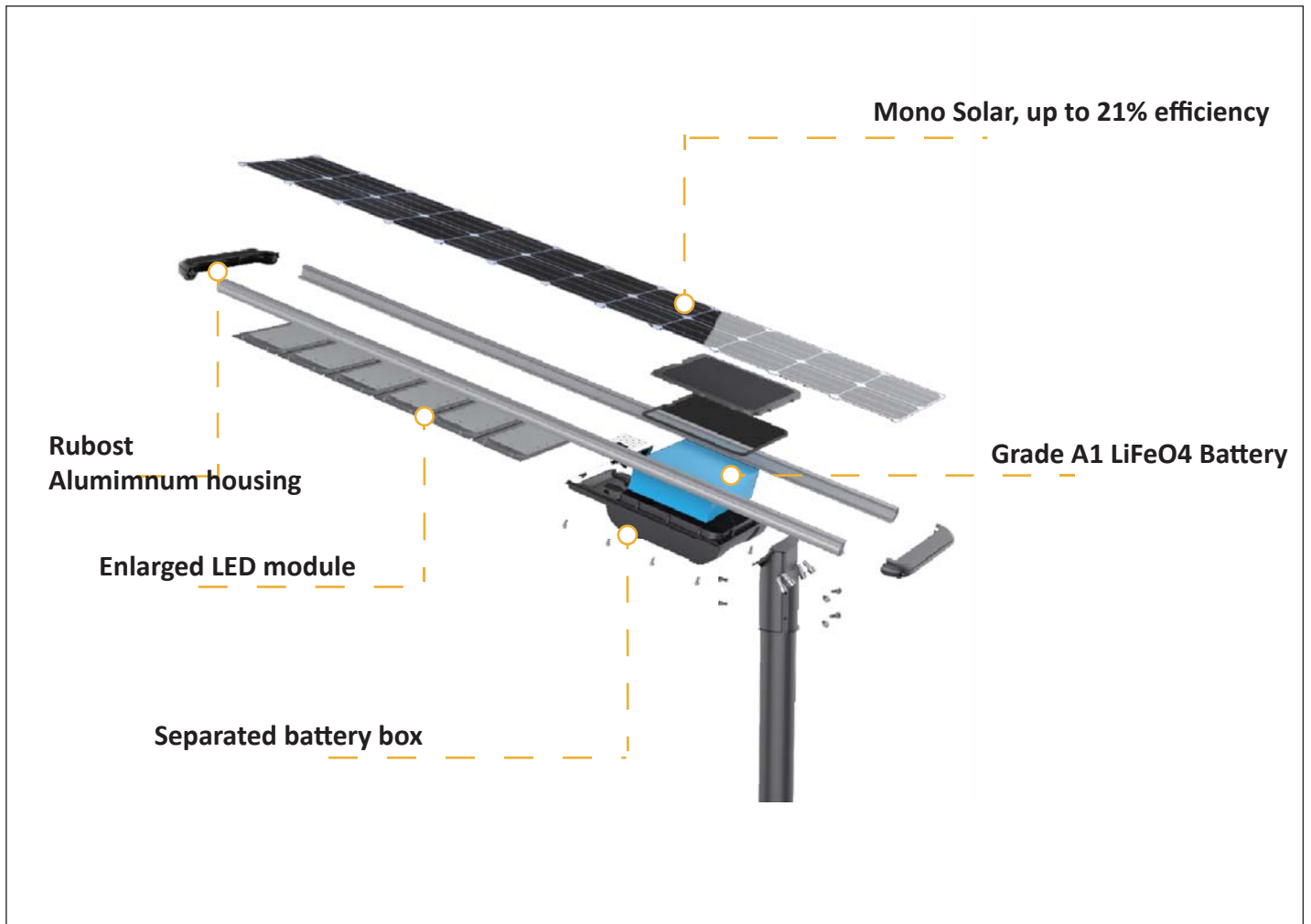

0° - 90° angle adjustable bracket



Separated battery box easy for maintenance



**Latest Bridgelux LED Chip
Up to 220lm/w**

Solar Charger Controller functions

The Controller of FB series adopts extremely simplified design, integrated controller, microwave induction, and magnetic switch in one, which makes the operation simple, the maintenance simple, and the stability is higher, what's more, there is a **stand-by circuit** inside, even one circuit failed, the other can still keep solar lights working well.

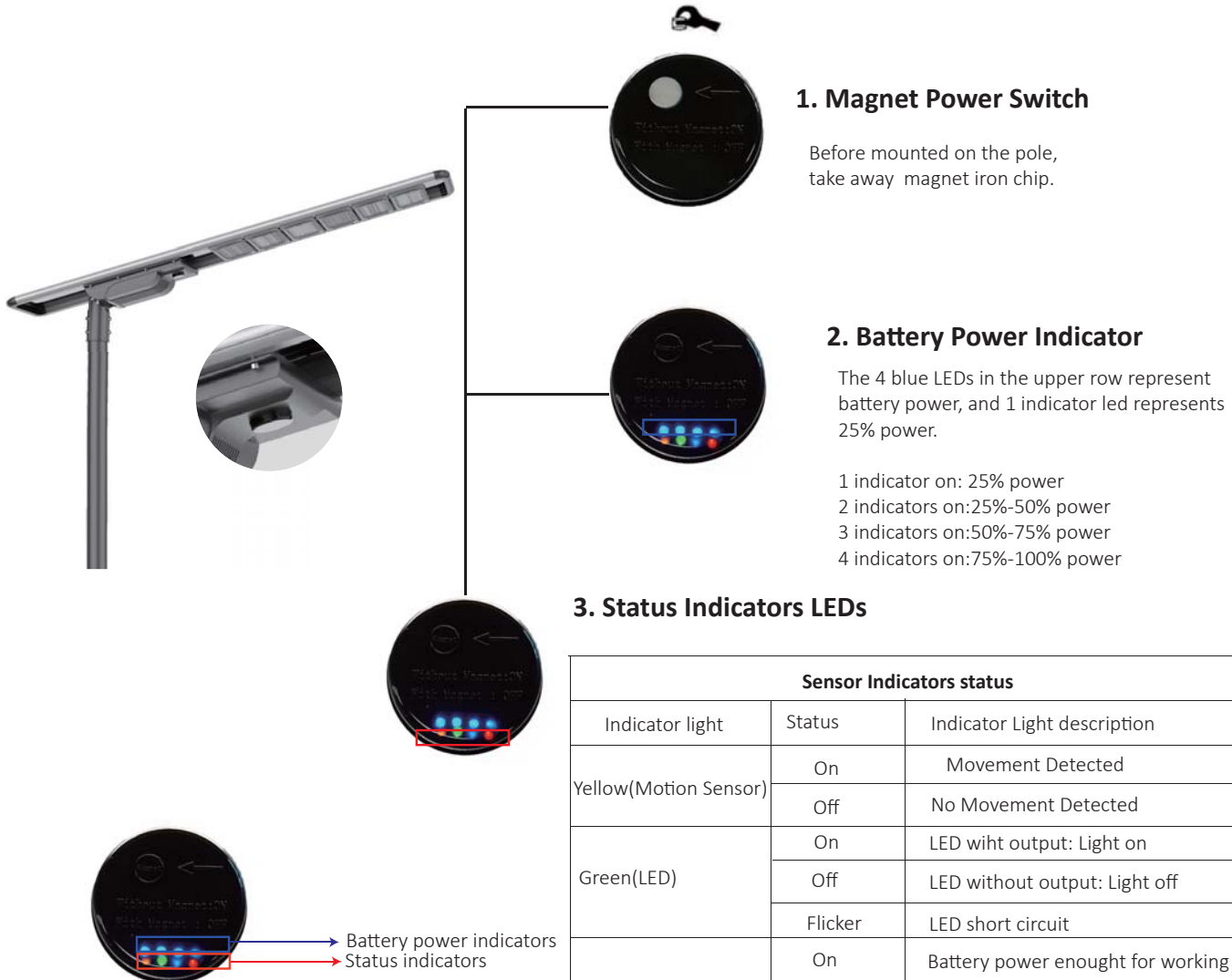

| Sensor Indicators status | | |
|--------------------------|----------------------------|------------------------------------------------------------------------------------------------------------|
| Indicator light | Status | Indicator Light description |
| Yellow(Motion Sensor) | On | Movement Detected |
| | Off | No Movement Detected |
| Green(LED) | On | LED with output: Light on |
| | Off | LED without output: Light off |
| | Flicker | LED short circuit |
| Blue(Battery) | On | Battery power enough for working |
| | Off | battery without output |
| | Flicker | battery undervoltage |
| Blue(solar panel) | On | battery charged fully |
| | Off | solar panel without output(in night) |
| | Flicker | solar panel is charging battery |
| Red & Green & Blue | Cycle light on in sequence | battery cable plugged in backwards, poor battery connection contact, faulty battery, no battery connected. |

Remote Control & Motion Sensor

Hi-Tech Remote Control: Equipped with a 433 remote control, which uses a drone remote control solution. The remote control distance can reach 30 meters, which can directly penetrate obstacles. At the same time, it can control multiple lamps.

Four lighting modes are available: The mode can be selected according to the seasonal sun. The most suitable mode can be selected according to the seasonal sunshine.

Motion Sensor control: When people come, the brightness will be changed to 100% brightness, after 30seconds after people go away, 25% brightness for stand-by.

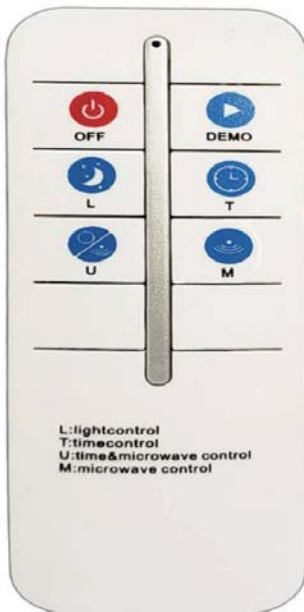

-  No matter day or night, light "OFF"
-  No matter day or night, light "on" for 1 minute.
-  At night, 12hrs full power.
-  At night, 4hrs full power+8hrs 30%
-  At night, 4hrs full power+8hrs motion sensor control.
-  At night, 12hrs motion sensor control.

Light Distribution Curve & Lighting Simulation Support

Lighting Distribution Curve

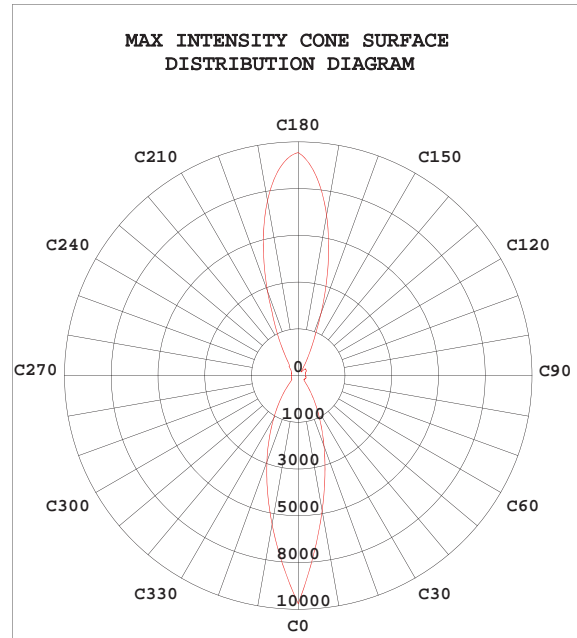
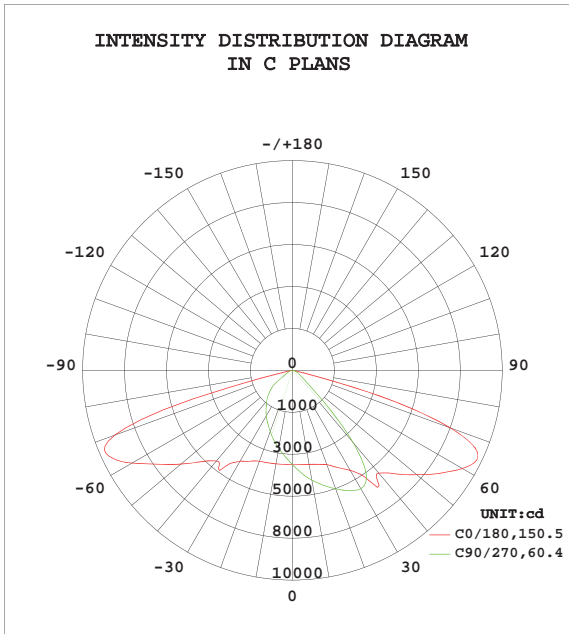

Dialux Lighting Simulation Support

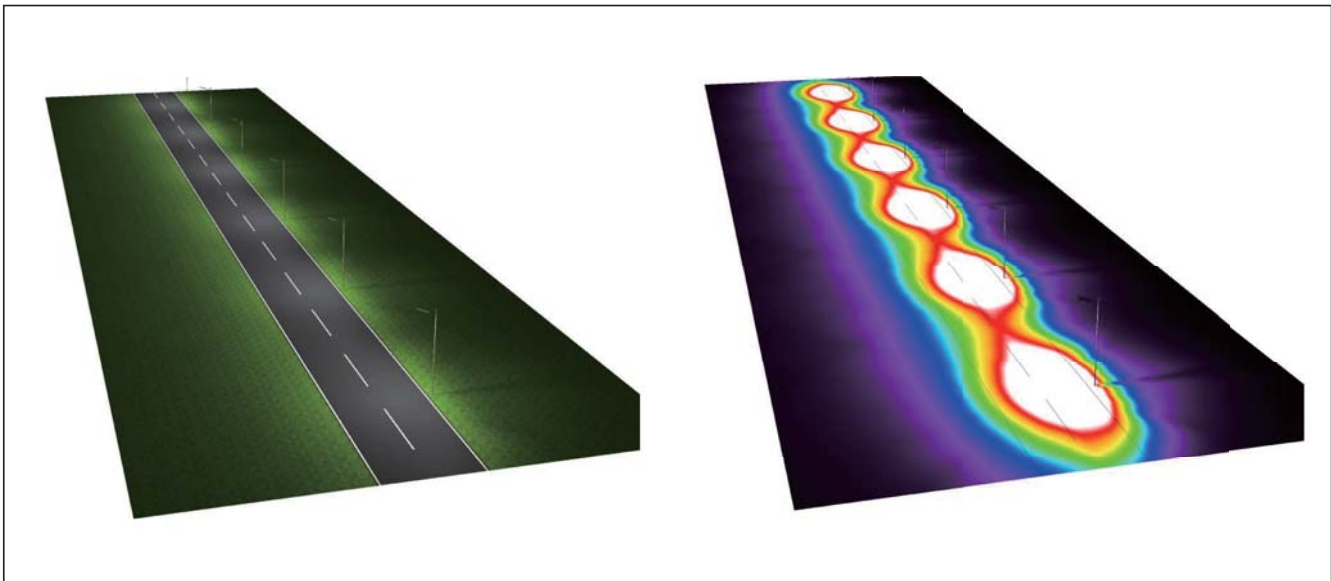

Packing

FB-40W/FB-50W/FB-60W Package
1 package: 1pc lamp per carton

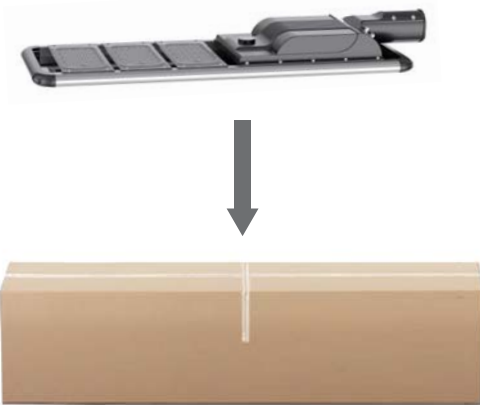

FB-80W/FB-100W/FB-120W Package
2 packages: 1pc lamp per carton +
1pc battery pack per carton

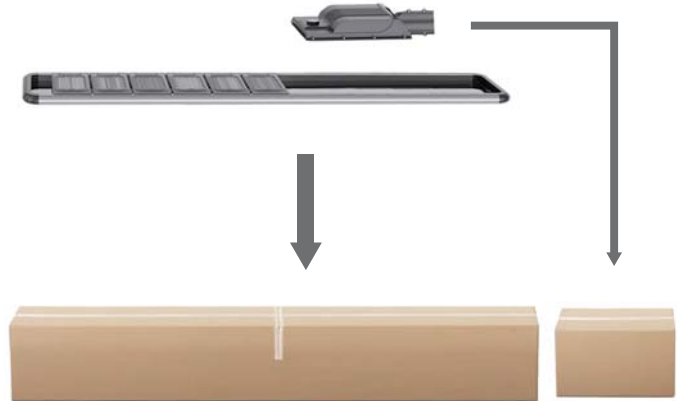

| Item | HE-FB-40W | HE-FB-50W | HE-FB-60W |
|------------------------|---------------|----------------|----------------|
| Carton Size(Lamp)/ 1PC | 920*160*450mm | 1140*170*450mm | 1140*170*450mm |
| G.W.(Lamp) / 1PC | 11.5kg | 14g | 14.6kg |

| Item | HE-FB-80W | HE-FB-100W | HE-FB-120W |
|---------------------------|---------------|----------------|----------------|
| Carton Size(Lamp)/ 1PC | 1630*10*450mm | 1940*100*450mm | 1940*100*450mm |
| G.W.(Lamp) / 1PC | 8.5kg | 12.4kg | 13kg |
| Carton Size(bracket) / PC | 630*380*150mm | 630*380*150mm | 630*380*150mm |
| G.W.(Solar Panel) / 1PC | 8.8kg | 9.7kg | 10.5kg |



Insatllation (More Steps in User Manual)



Post Top Installation



Side Entry Installation

1. Use the supplied screws to fix the bracket on the lamp.

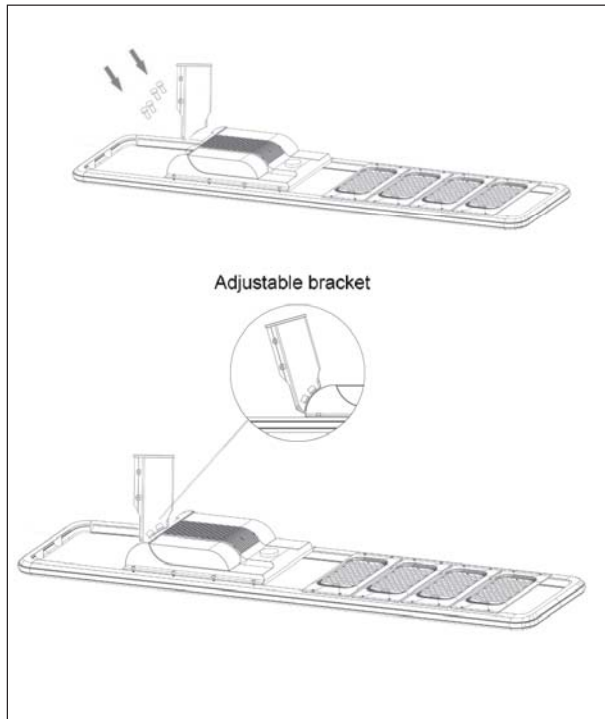

2. Use the supplied screws to fix the lamp on the post.



Compliance and Standards

1. Insulation Resistance

The IR shall be at least 50MΩ when apply 500Vdc between primary and secondary

2. Dielectric Strength (Hi -pot)

Input To Output 3750Vac 60Hz 1minute $\leq 3\text{MA}$

When AC voltage of 3.75KV is applied, and the voltage applied to the insulation under test is gradually raised from zero to the prescribed voltage in 1s, and held at that value for 60s between the inputs. and output and between the input and housing, the current sensitivity shall be less than 5mA. After this test, the adapter shall exhibit no electrical and mechanical abnormalities.

3. Leakage Current

The leakage current shall be less than 0.25mA for class II when power supply is operated maximum input voltage and maximum load.

4. Safety Standard

34A-1501NP IEC:60598-1:2008 IEC61347-1/A1:2010 IEC61347-2-13:2006 IEC62031:2008
IEC62471:2006 IEC62471-2:2009: Passed
EN60598-1/A11:2009 EN61347-2-13:2006 EN61347-1/A1:2011 EN62031:2008 EN62471
EN61195:1999 EN62493:2010: Passed

5. EMI/EMS Standard

EN55015:Passed
EN61000-3-2:Passed
EN61000-4-2:Passed